



by NANCY VIAU  
illustrated by JORGE LACERA

classroom visit  
**ACTIVITIES**

AUTHOR- NANCY VIAU

ILLUSTRATOR- JORGE LACERA

PUBLISHER- TWO LIONS

RESOURCES DESIGNED BY: the subway side

# CLASSROOM VISIT

## activity guide

### PRE-READING: PREDICTIONS

Show students the cover and take a picture walk through the illustrations. Encourage students to write or draw a prediction they have before reading. Revisit after reading and ask students to reflect on their predictions.

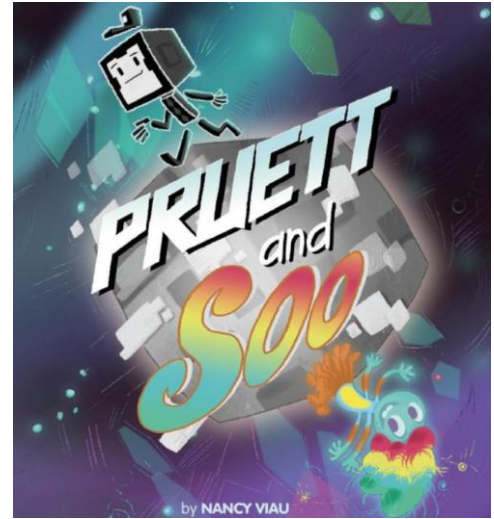

### POST-READING: ASKING QUESTIONS SPINNER

Copy the ASKING QUESTIONS spinner on white copy paper. Using a pencil and a paperclip (as pictured on the game board) create a spinner. Working with a partner, students will take turns spinning the spinner and asking their partner WHO, WHAT, WHERE, WHEN, and WHY questions about the story.

### ROLL AN ALIEN

Copy the ROLL AN ALIEN tables on white copy paper. Decide whether students will use the alien templates or simply draw their alien. Students will roll the dice three times and follow the table across. Depending on what they roll, students will draw or assemble craft templates to create a one-of-a-kind alien!

### YOU WILL NEED:

- Colored construction paper
- Art supplies
- Glue sticks
- Scissors
- Pencils
- Paperclips
- Dice



Name: \_\_\_\_\_

RESOURCES DESIGNED BY: *the sunny side*

# MAKING PREDICTIONS

MY PREDICTION	WHAT ACTUALLY HAPPENED
_____	_____
_____	_____
_____	_____
_____	_____
_____	_____
_____	_____
_____	_____

WAS YOUR PREDICTION CORRECT?

\_\_\_\_\_

\_\_\_\_\_

\_\_\_\_\_

\_\_\_\_\_

Name: \_\_\_\_\_

RESOURCES DESIGNED BY: *the sunny side*

# ASKING QUESTIONS

## SPINNER GAME

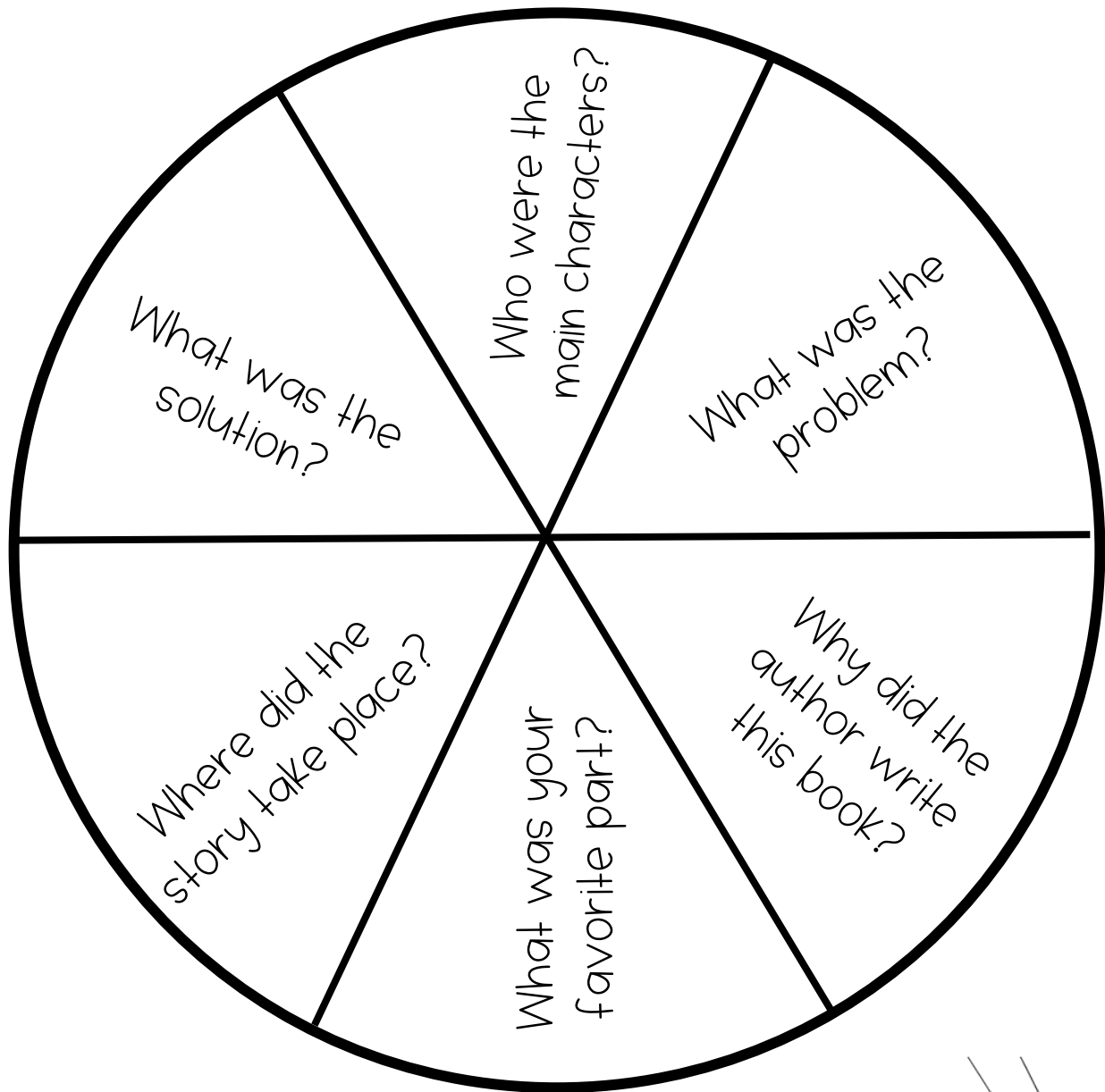

Directions: Think about the story. Use the pencil and paperclip to create a spinner. Then, take turns spinning the spinner and ask your partner about what happened in the story.

### You will need:

- A pencil
- A paperclip
- A partner

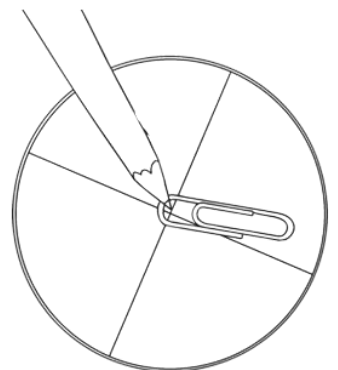

# ALIEN CRAFT

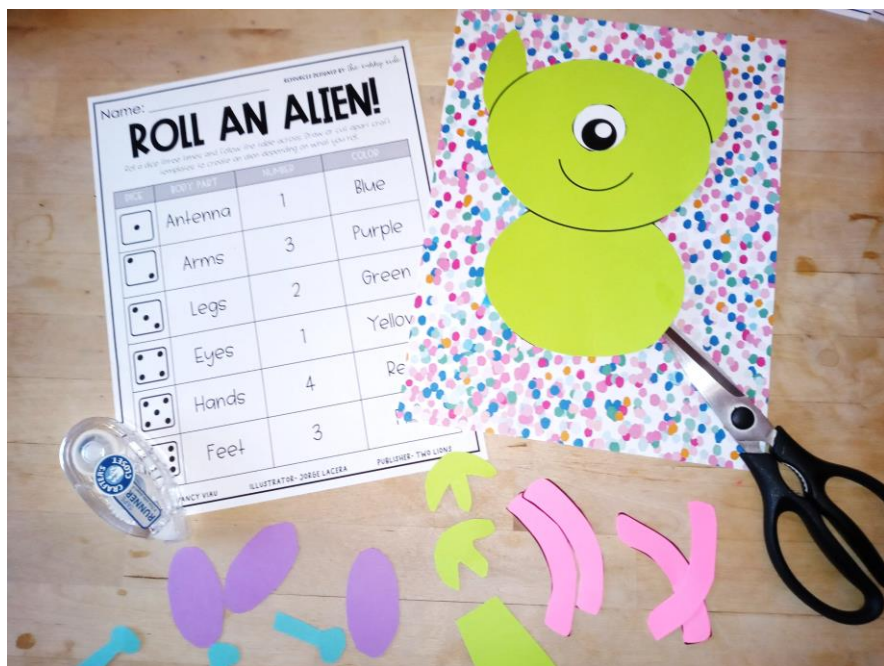

Copy alien templates on colored construction paper or white paper for students to color.

RESOURCES DESIGNED BY: the subway side

Name: \_\_\_\_\_

RESOURCES DESIGNED BY: *the sunny side*

# ROLL AN ALIEN

Roll a dice three times and follow the table across. Draw or cut apart craft templates to create an alien depending on what you roll.

DICE	BODY PART	NUMBER	COLOR
	Antenna	1	Blue
	Arms	3	Purple
	Legs	2	Green
	Eyes	1	Yellow
	Hands	4	Red
	Feet	3	Pink

Name: \_\_\_\_\_

RESOURCES DESIGNED BY: *the sunny side*

# ROLL AN ALIEN

---

Alien's Name

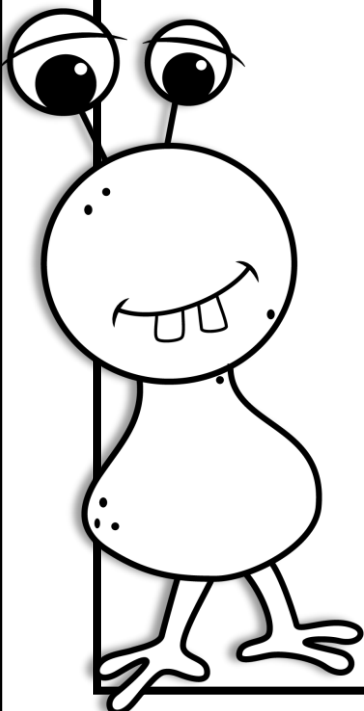

# ALIEN TEMPLATES

Copy on bright colored construction paper

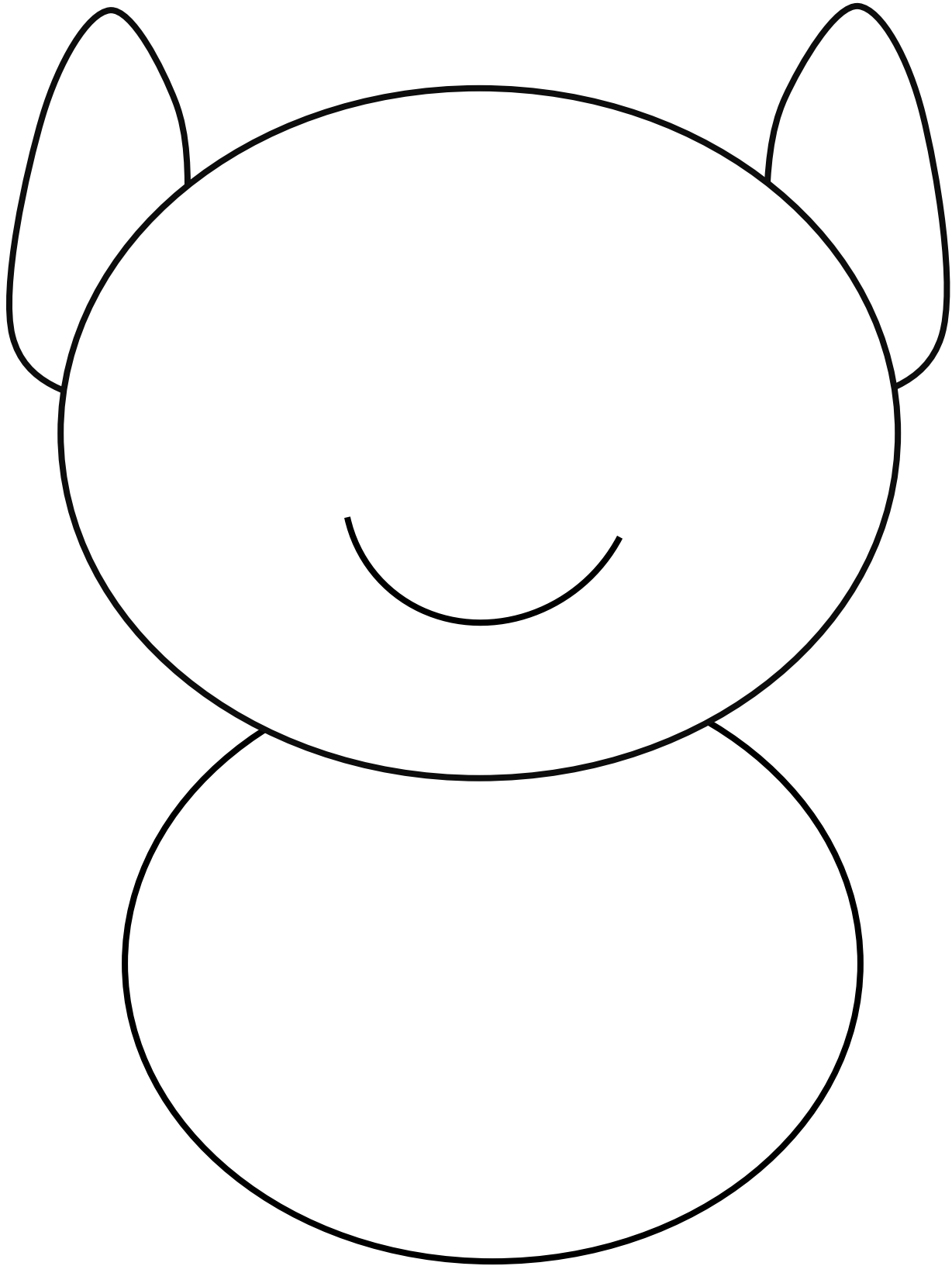



# ANTENNA TEMPLATES

Copy on bright colored construction paper

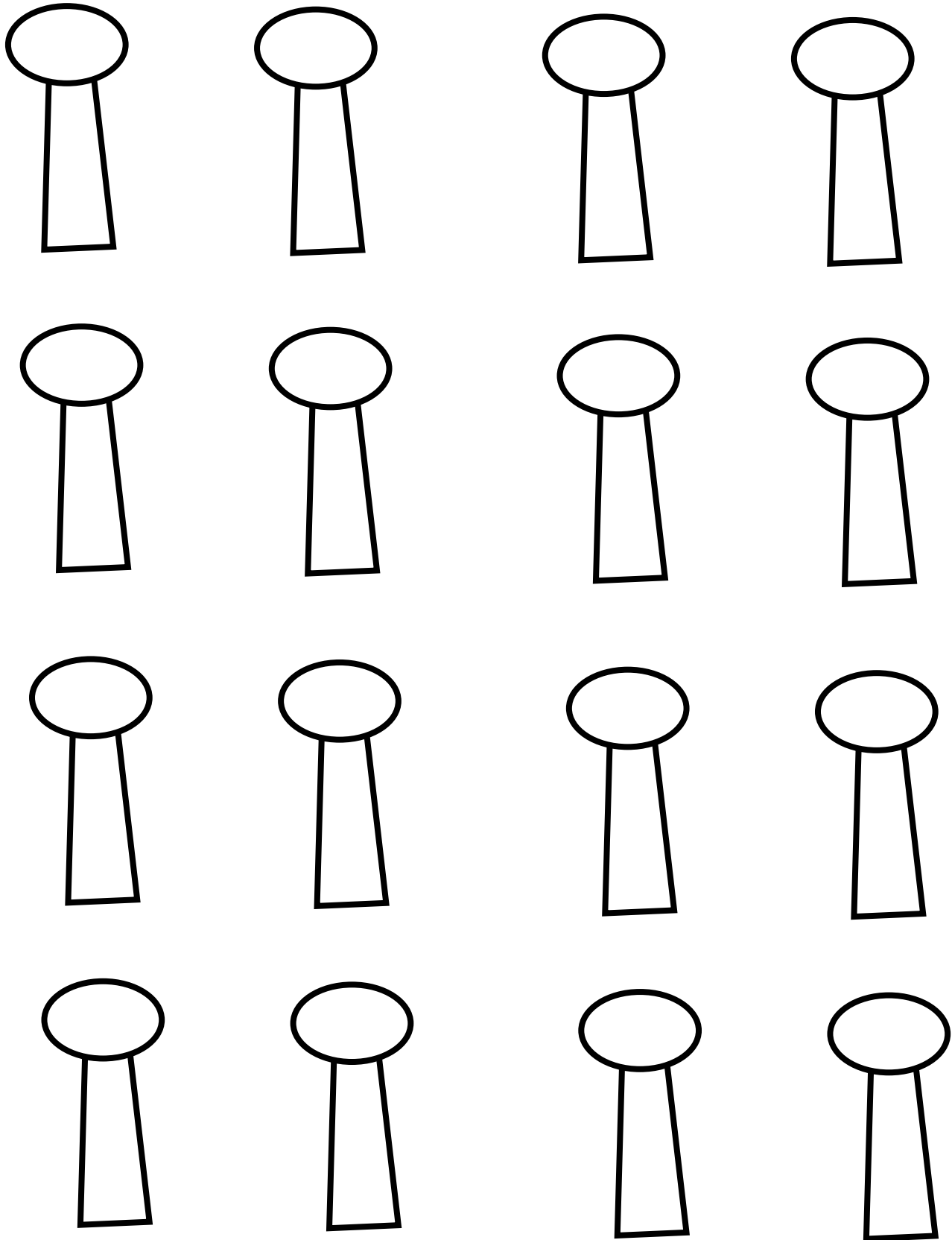

# ARM TEMPLATES

Copy on bright colored construction paper

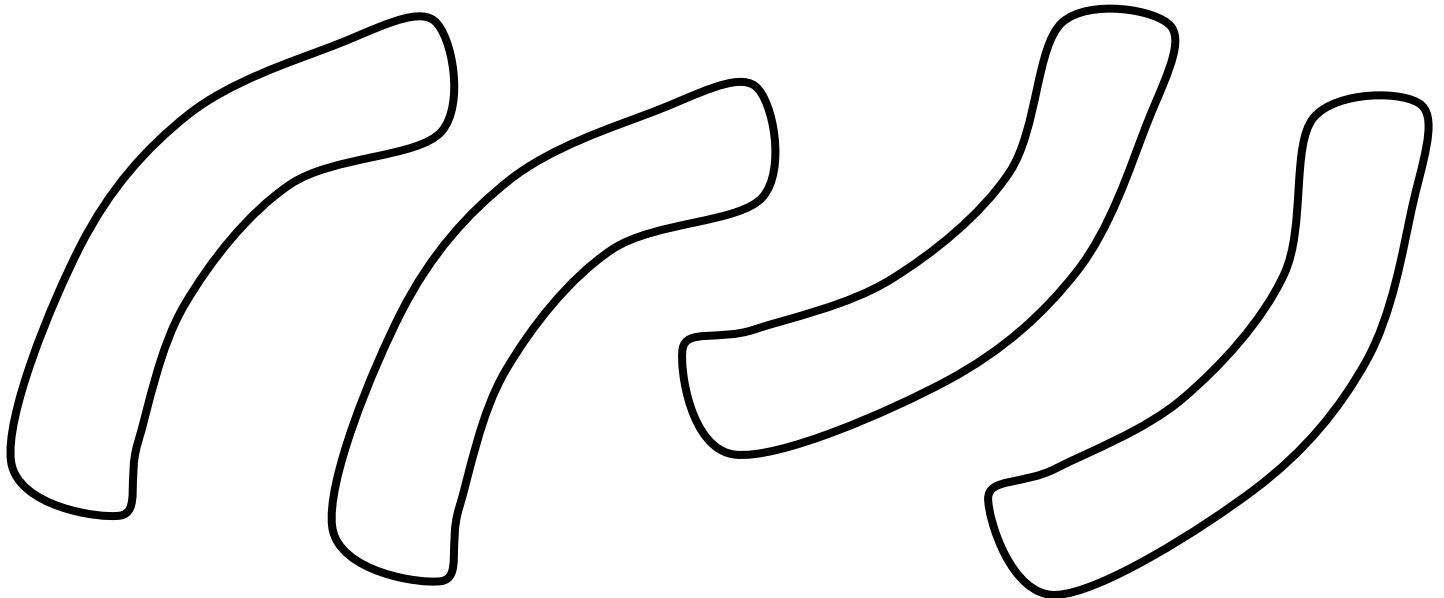
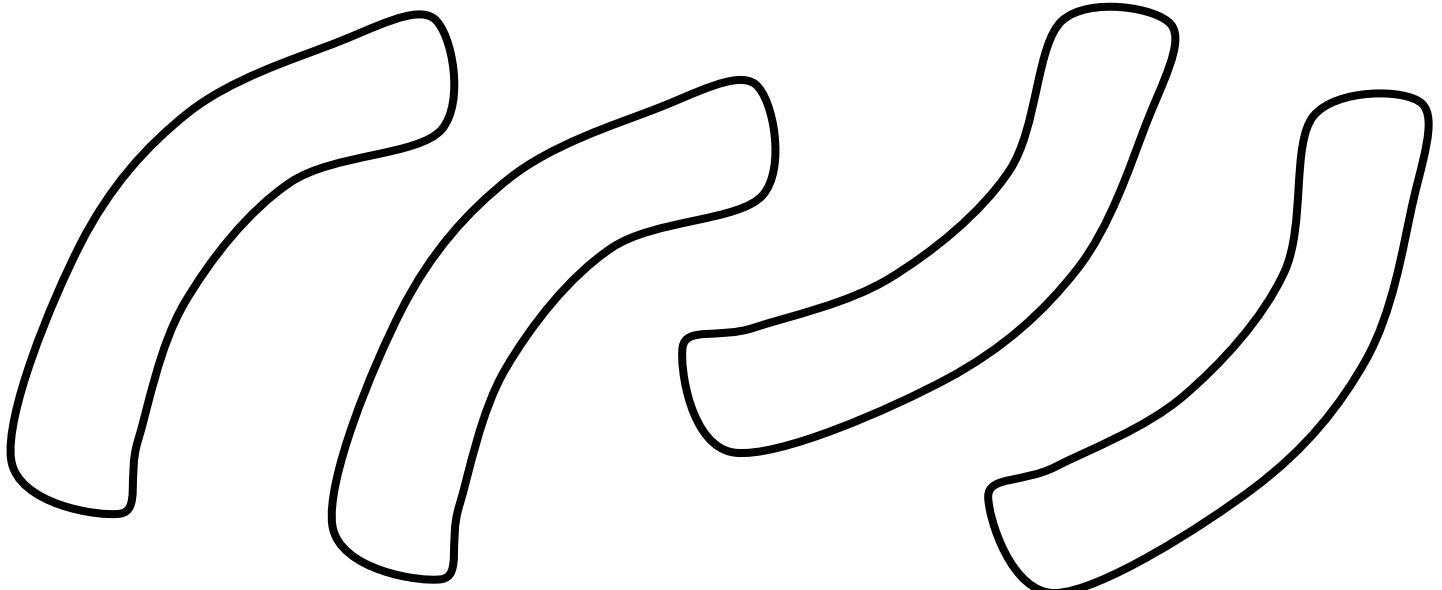

RESOURCES DESIGNED BY: the subway side

# LEG TEMPLATES

Copy on bright colored construction paper

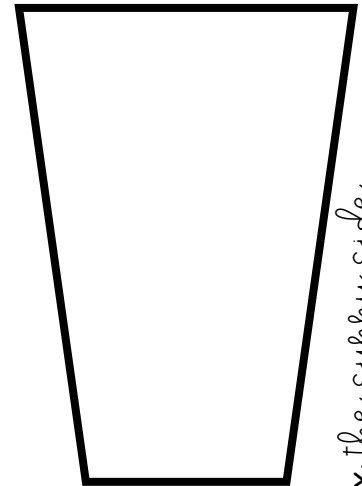
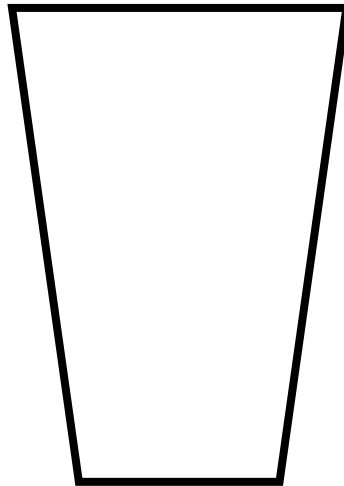
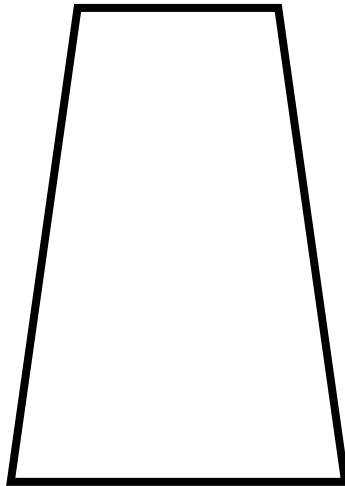
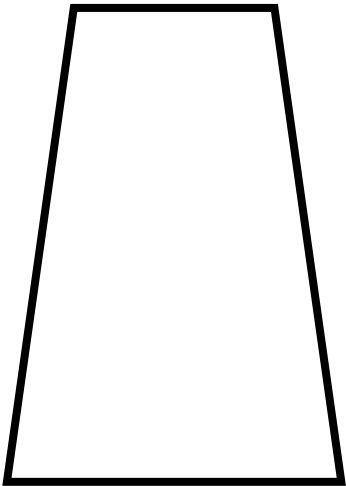
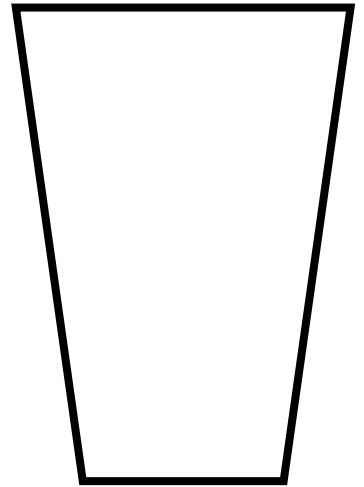
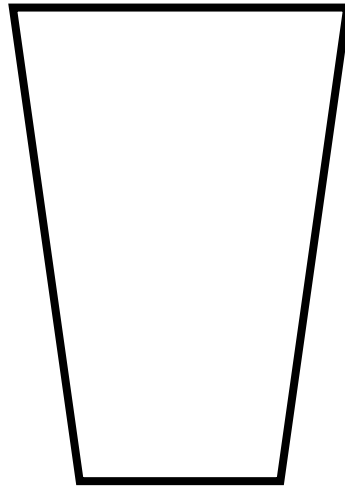
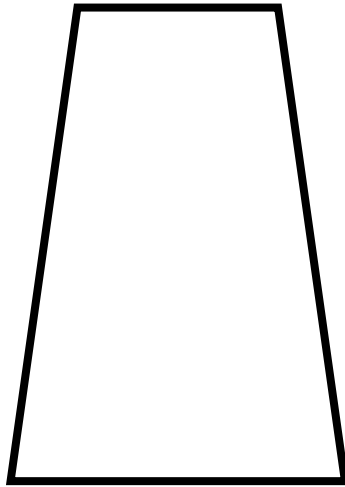
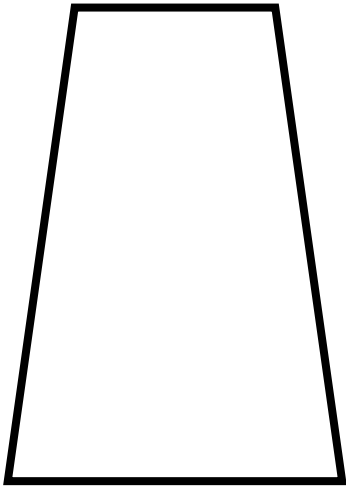

RESOURCES DESIGNED BY: *the subway side*

# HAND TEMPLATES

Copy on bright colored construction paper

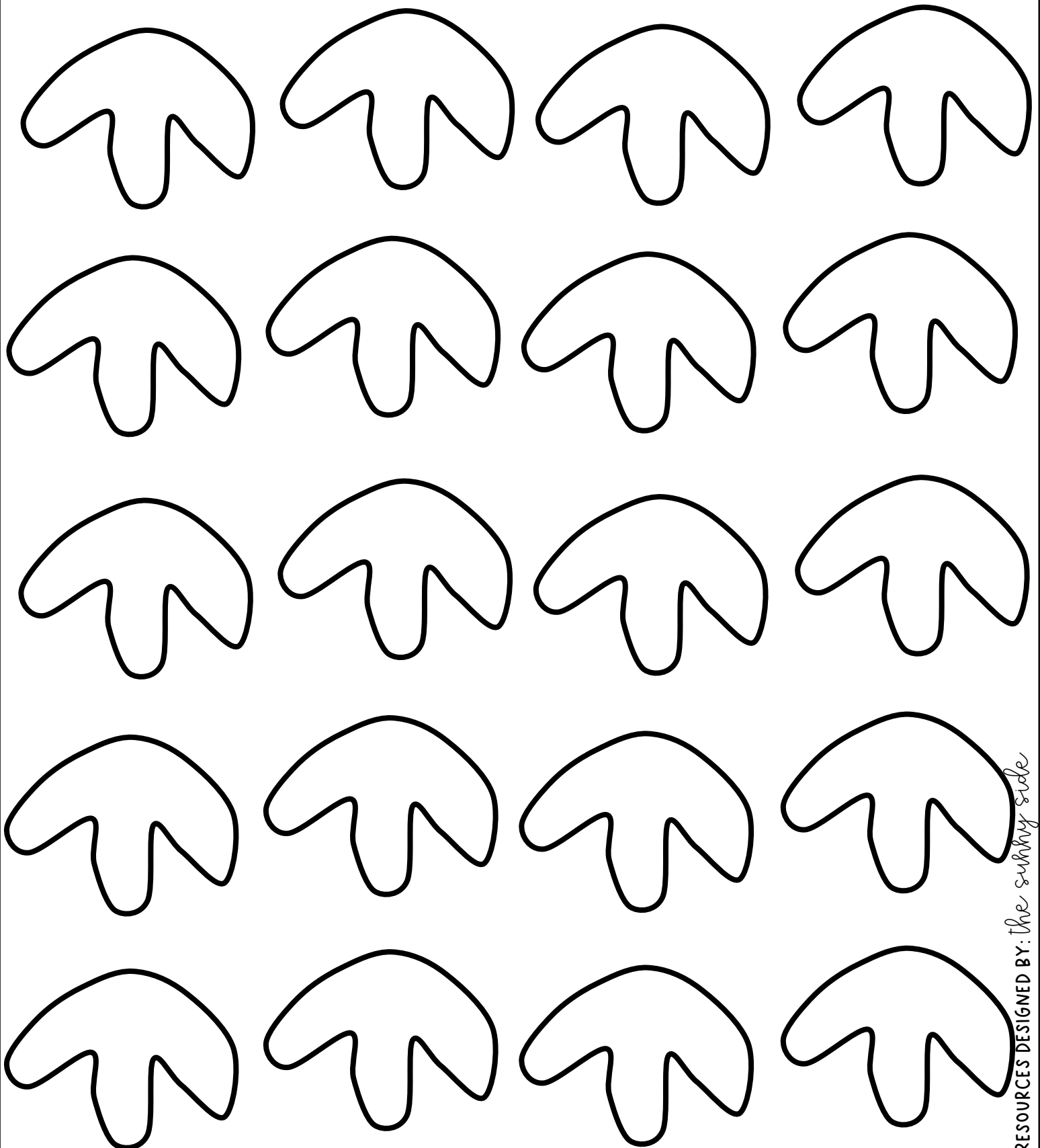

RESOURCES DESIGNED BY: the subway side

# FEET TEMPLATES

Copy on bright colored construction paper

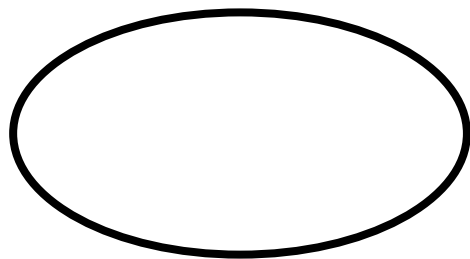
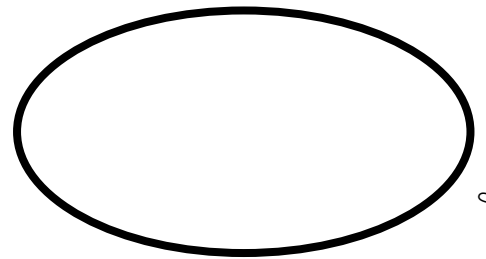
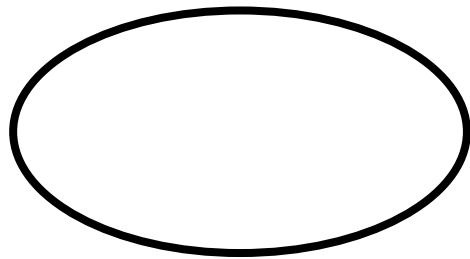
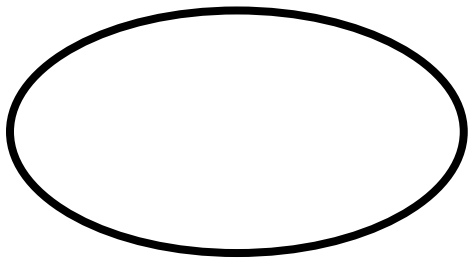
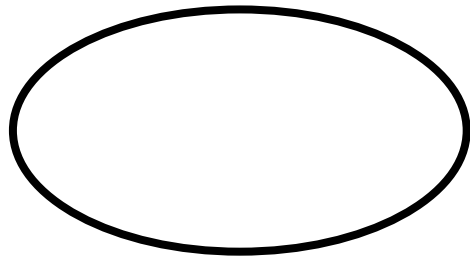
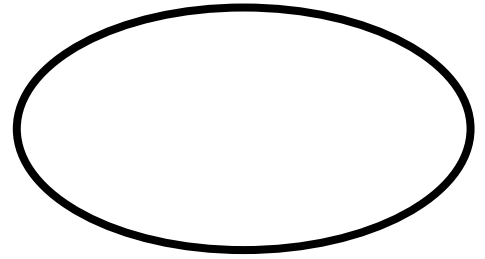
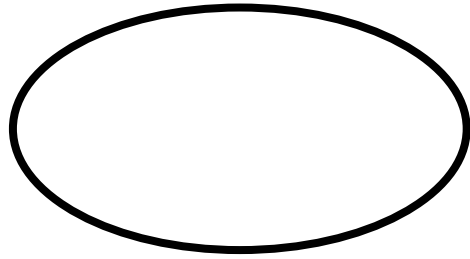
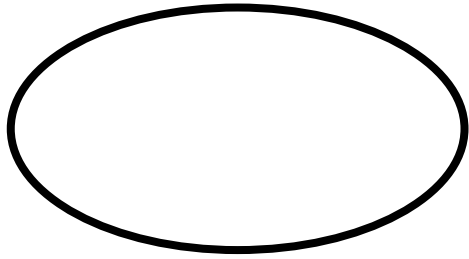

# EYE TEMPLATES

Copy on white construction paper

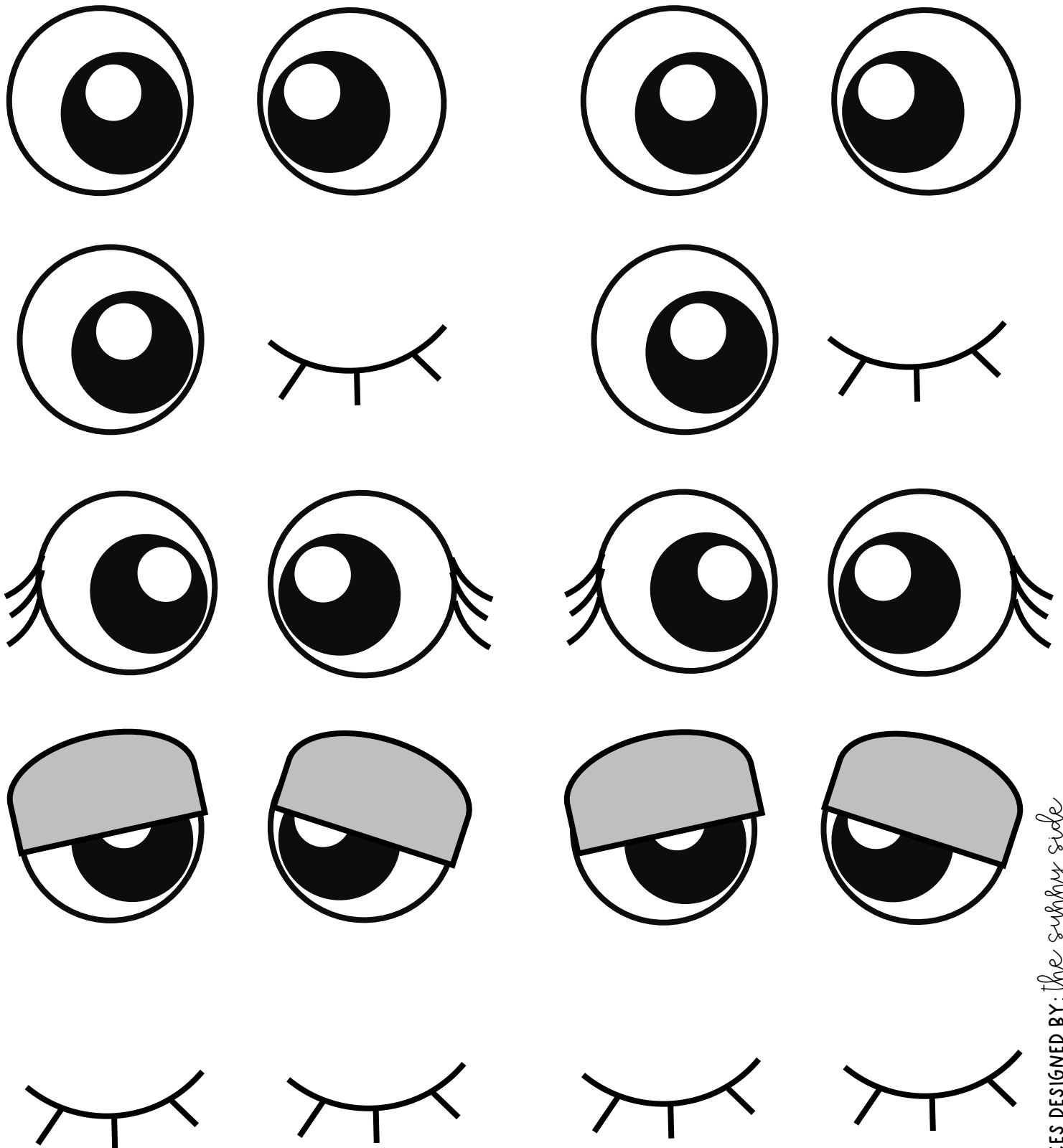

RESOURCES DESIGNED BY: the subway side



# CREDITS PAGE

## The author – Nancy Viau

NANCY VIAU is the author of the following picture books: Pruet and Soo, Today Is a Beach Day!, First Snow, City Street Beat, Storm Song, Look What I Can Do! and Splish, Splash! First to Last (Forthcoming 2023). She is also the author of several middle-grade novels, including Samantha Hansen Has Rocks In Her Head, Something Is Bugging Samantha Hansen, Just One Thing! and Beauty and Bernice. A former teacher and librarian, and forever a kid-at-heart, Nancy loves to visit schools, libraries, and bookstores across the U.S. to present assembly programs and writing workshops. Connect with her on Twitter or Instagram: @NancyViau1 or via her site: [www.NancyViau.com](http://www.NancyViau.com).



## CONNECT WITH HER



## The illustrator – Jorge Lacera

Jorge Lacera was born in Colombia and grew up in Florida. He attended Ringling College of Art and Design and has worked as an artist or art director at major gaming studios and entertainment companies. He is the illustrator of *Zombies Don't Eat Veggies* by Megan Lacera and *XO, Exoplanet* by Deborah Underwood. He lives in Canada with his family. Learn more at [www.studiolacera.com](http://www.studiolacera.com)





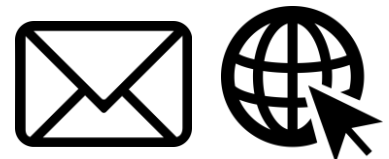

THESE RESOURCES WERE DESIGNED BY MOLLY AT  
*the sunny side*

EMAIL OR VISIT HER WEBSITE FOR MORE  
INFORMATION.







# YOU MAY

-  Use this item for personal use.
-  Use this item in your classroom and with your students.
-  Copy this item for your class and your students.
-  Copy this item for your child and personal home use.

# YOU MAY *not*

-  Copy or modify any part of this document.
-  Offer this document for sale.
-  Post this item on a website; personal, school, or district without permission.



THESE RESOURCES WERE DESIGNED BY MOLLY AT  
*the sunny side*  
EMAIL OR VISIT HER WEBSITE FOR MORE  
INFORMATION.

